

Parallel Direct Between

This mounting method is to be used when the stationary curtain run is between two parallel I-Beams or trusses. This mounting method enables placement of the curtain between the two parallel structures.

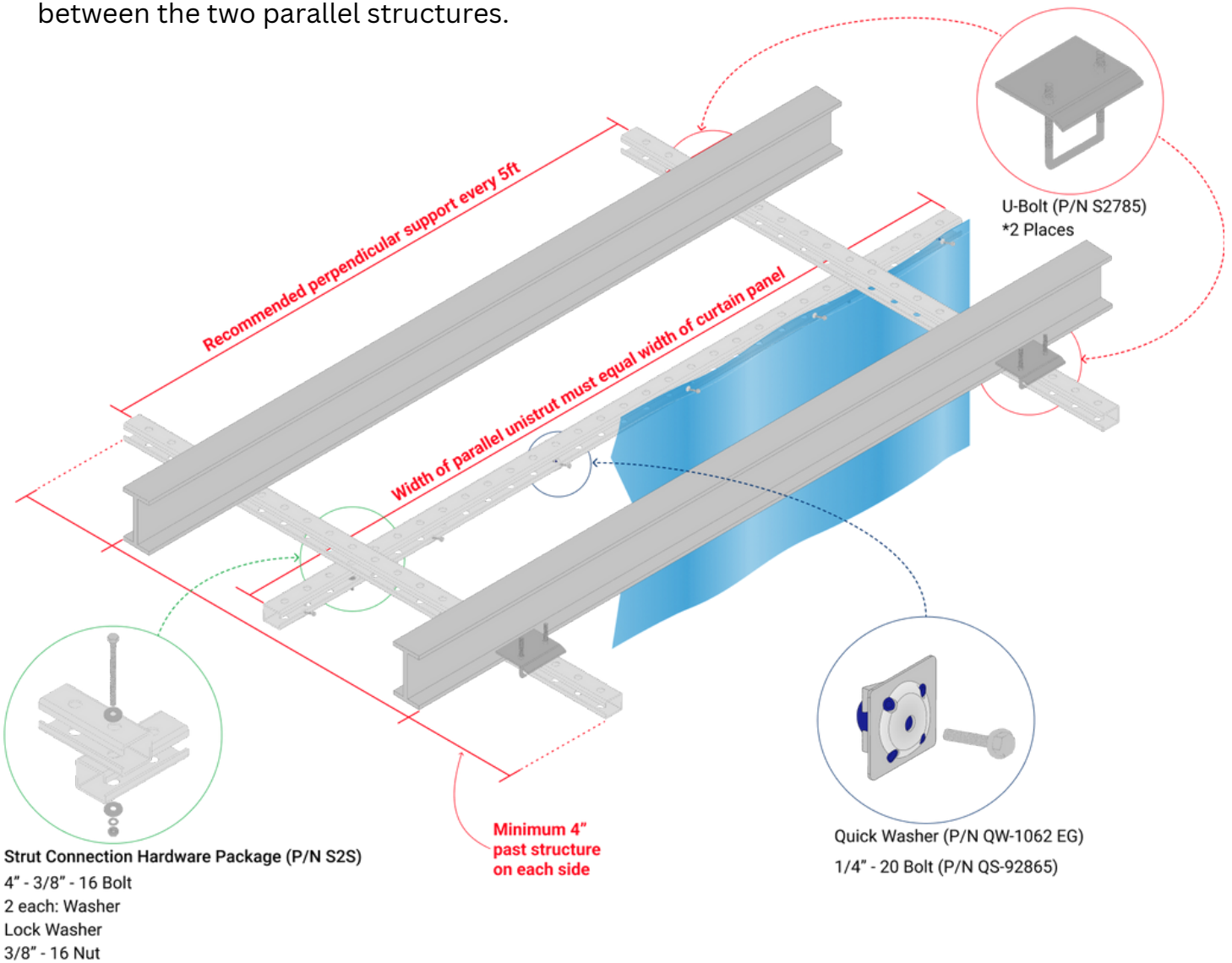

Strut Connection Hardware Package (P/N S2S)
4" - 3/8" - 16 Bolt
2 each: Washer
Lock Washer
3/8" - 16 Nut

Quick Washer (P/N QW-1062 EG)
1/4" - 20 Bolt (P/N QS-92865)

STEP 1 - Make sure you received all the parts you ordered

- Compare the parts that you received with the packing list.
- To visually identify the parts listed on your packing list, please consult the components list found in these installation instructions spanning the last three pages.

Parallel Direct between existing structure

STEP 2 - Mount the **perpendicular** Unistrut to the I-Beams/Trusses

Place a **perpendicular** supporting Unistrut every 5 feet.

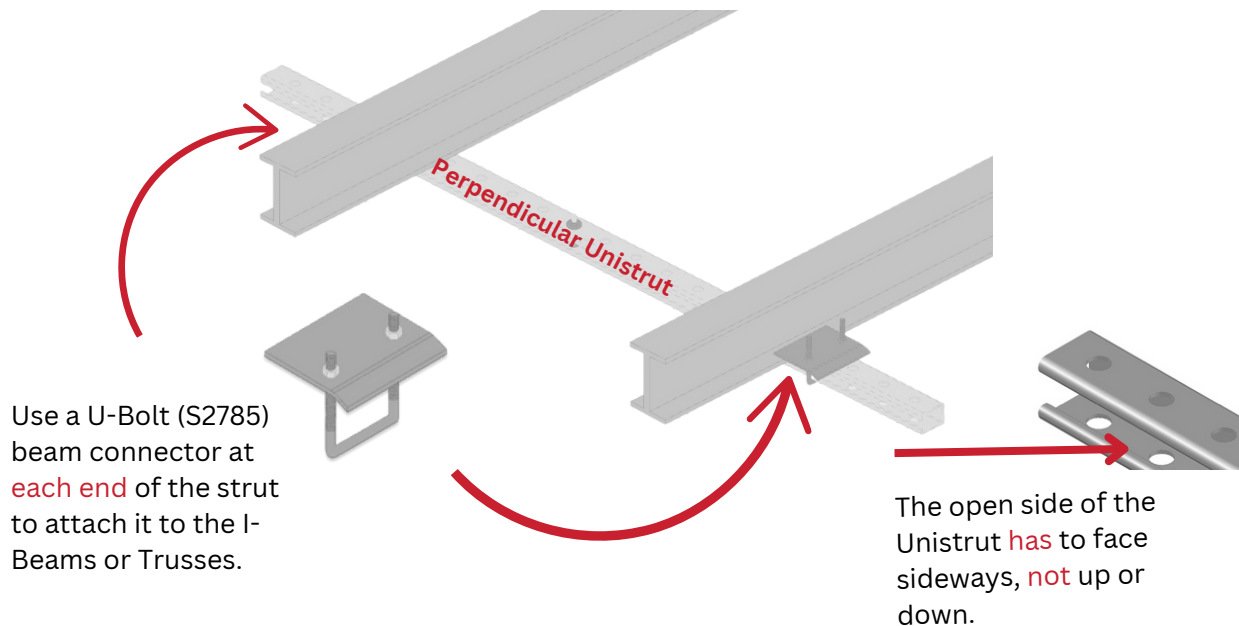

The U-Bolts (S2785) must be placed on the **outside** of the beam for stability. The Unistrut must have a 4" minimum overhang on each side of the I-Beams or Trusses. Space the remaining Unistrut 5' on center and attach to the structure using the same method as the first one.

STEP 3 - A good time to check the height!

Important: The **top** of the Unistrut that **the curtain gets mounted to** **must** be installed at **_____ ft. _____ in. off of the floor.**

This dimension is also located atop your quotation. There will be a 1" gap between the bottom edge of the curtain and the floor. A floor sweep will cover the open space at the bottom of the curtain if it is included in your purchase. Make sure that the strut is leveled.

Parallel Direct between existing structure

STEP 4 - Attach the **parallel** Unistrut run.

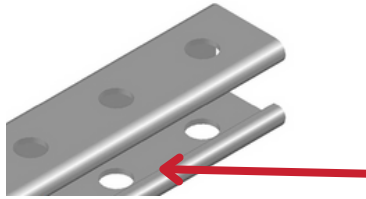

Front side is the open Unistrut side. The curtain will be attached to this side.

Important strut position: Make sure the open side of the strut is facing sideways, **not** up or down, and outward of the enclosed area. This is the side the curtain will get attached to. The front side of the curtain always faces outward.

The assembled width of the Unistrut (S-1000H3) in the parallel run **must** be equal to the width of the curtain.

Using the Strut Connection **Hardware Package S2S (included)** attach the first Unistrut along the parallel run to the perpendicular mounted Unistrut's.

This **parallel run** of strut is what the curtain will be attached to.

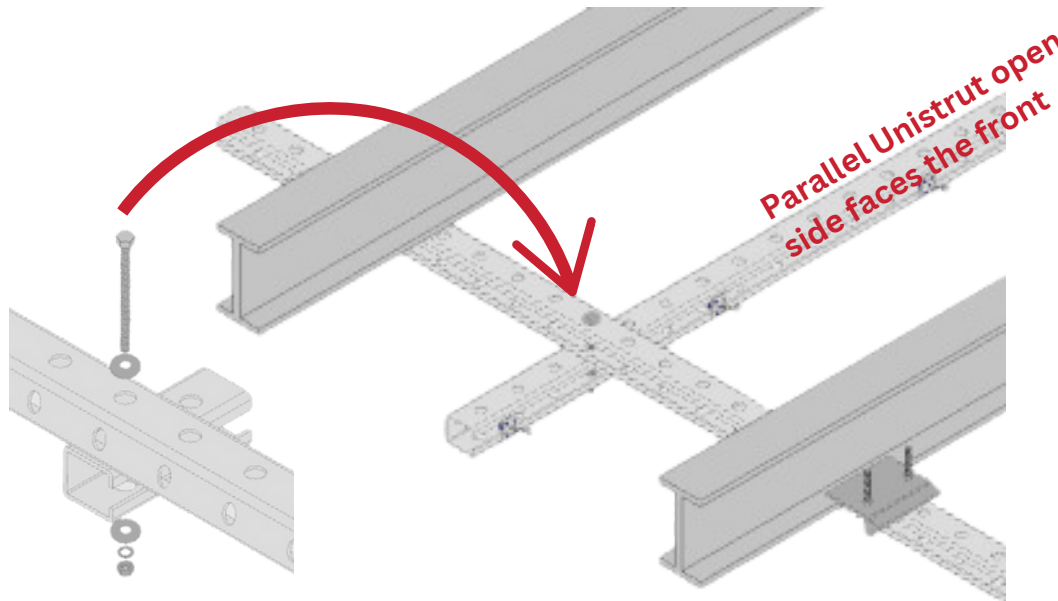

Strut to strut connection hardware package (P/N: S2S)

- 1 each 4" L x 3/8" -16 Bolt
- 2 each washers
- 1 each lock washer
- 1 each 3/8" -16 Nut

Parallel Direct between existing structure

STEP 5 - Connect the **parallel** Unistrut to each other.

The Unistrut sections can be connected either as soonest you have two Unistrut's hung up or in the end ones all the Unistrut's are hung up. At each Unistrut joint use either a **straight plate connector (S-1067)** or a **Heavy duty Connector (S-1377 EG)**. Four bolts and washers are provided for each connection.

Depending on the overall weight of your curtain assembly you will receive either the Unistrut connector or the connecting plates.

Unistrut connecting plate

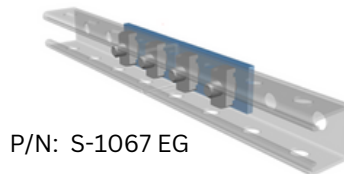

Unistrut connector

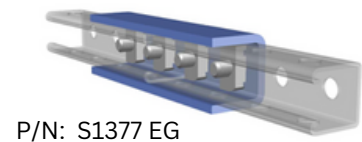

Repeat **mounting** and **connecting** the **parallel** Unistrut to the **perpendicular** Unistrut until you reach the finished width of the curtain section. If required, cut the last Unistrut to size.

STEP 6 - Attach the curtain to the **parallel** Unistrut run.

The curtain gets attached using **Quick Washers (QW-1062EG)** and a **Bolt (QS-92865)**. You have the option to load the Quick Washers into the channel from either the side or the front. Most customers prefer loading the quick washers from the front and twisting them 90° (as indicated by the arrows on the QW) to ensure stability. Once in this position, they can easily be moved sideways within the channel to align with the grommet positions on your curtain.

To begin, line a vertical edge of the curtain with one end of the Unistrut. **Make sure** the **front side** of the curtain faces the outside of the enclosure. Insert a bolt through the grommet on the top edge of the curtain and thread it into the Quick Washer. Repeat this step for **each** grommet along the top of the curtain.

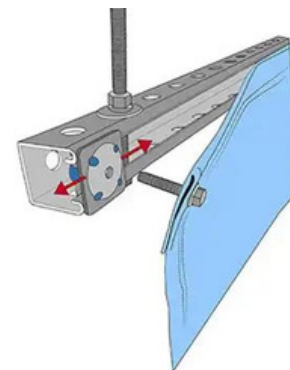

STEP 7 - Important: Secure all hardware connections by tightening all the nuts and bolts. **This ensures a safe installation.**

1" Threaded Rod Clamp

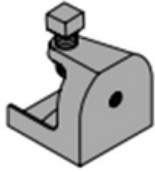

P/N: THRCL

Quantity: _____

**Side Bolt 3/8" - 16,
3/4" long**



P/N: BLT

Quantity: _____

1/2" Beam Clamp



P/N: BC-6H375

Quantity: _____

Unistrut holes on 3 sides

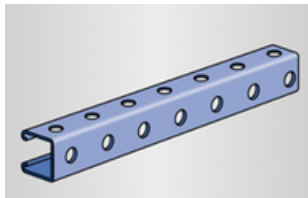

P/N: S-10003-length
Available 2' to 10'
9/16" dia.holes
1.7/8" on center

Quantity: _____

U-Bolt

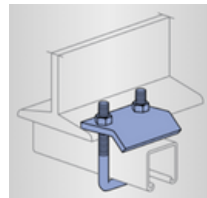

P/N: S2785
incl. 2 nuts

Quantity: _____

**Quick Washer
1/4" x - 20 thread hole**

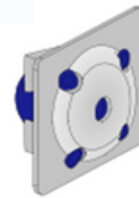

P/N: QW-1062 EG

Quantity: _____

**Side Bolt 1/4" - 20,
1.25" long**



P/N: QS-92865

Quantity: _____

**3/8" - 16 Threaded Rod
Incl. 3 ea. Nuts**



P/N: THR Length
Available in 2', 3', 4', 6'

Quantity: _____

**Threaded Rod
Side Plate**

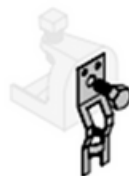

P/N: STHRMP

Quantity: _____

11/16" Swivel Clamp



P/N: SLTHRCL

Quantity: _____

**Strut to strut connection
Hardware package**

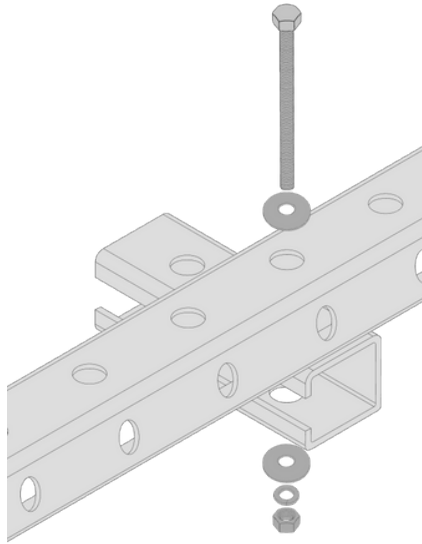

P/N: S2S Includes: 1 each Bolt 3/8" - 16, 4" long
2 each washers
1 each lock washer
1 each nut 3/8" - 16

Quantity: _____

**Strut connection to Threaded Rod
Hardware package**

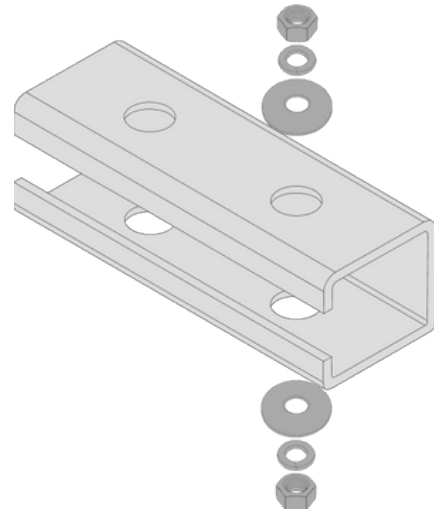

P/N: TROD2S Includes: 1 each washer
1 each lock washer
1 each nut 3/8" - 16

Quantity: _____

Threaded Rod to Truss

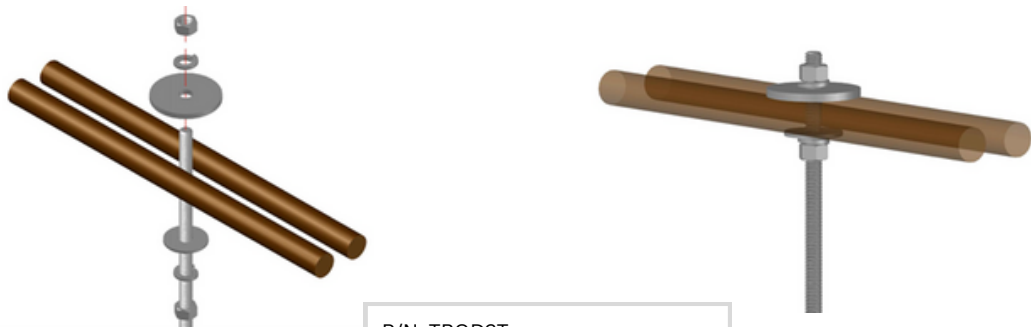

P/N: TROD2T
Includes: 1 each big flange washer
1 each regular washer
2 each lock washers
2 each 3/4" - 16 nuts

Quantity: _____

Unistrut connector

4 X

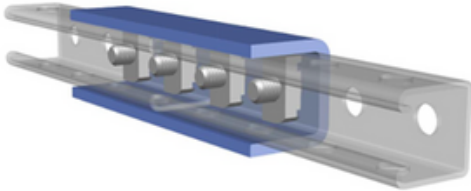

4 X

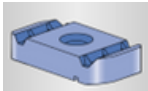

P/N: S1377 EG Includes : 4 each Bolt 1/2" - 13, 1.25" long
4 each threaded nuts

Quantity: _____

Unistrut connecting plate

4 X

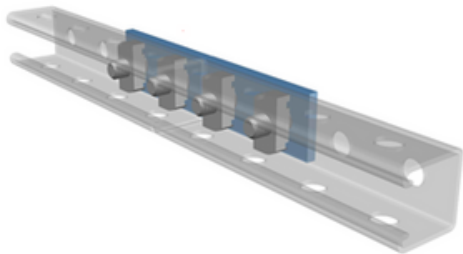

4 X

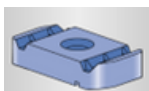

P/N: S-1067 EG Includes : 4 each Bolt 1/2" - 13, 1.25" long
4 each threaded nuts

Quantity: _____

Curtain/Panels

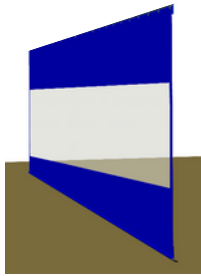

Quantity: _____

Valance



Velcro attaches to the side of the track

Quantity: _____

Chain Weighted Bottom

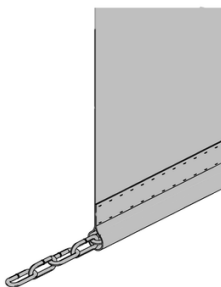

Sewn into the hem

Quantity: _____

Floor Sweep



Velcro attached to the bottom hem

Quantity: _____

Wall Attachment Strip



Wall attachment strip

Quantity: _____

D-Ring



D-Ring with Carabiner

Quantity: _____

Adhesive Velcro



Color - Black or White
1" or 2" wide

Quantity: _____

6" Wide Vinyl Tape



Color - Royal Blue, Gray, Black, or White. Comes on a roll or 4' long strips

Quantity: _____